

Quintiesse - QN-SCHOLAR3 - Scholar 3 Light Wall Light

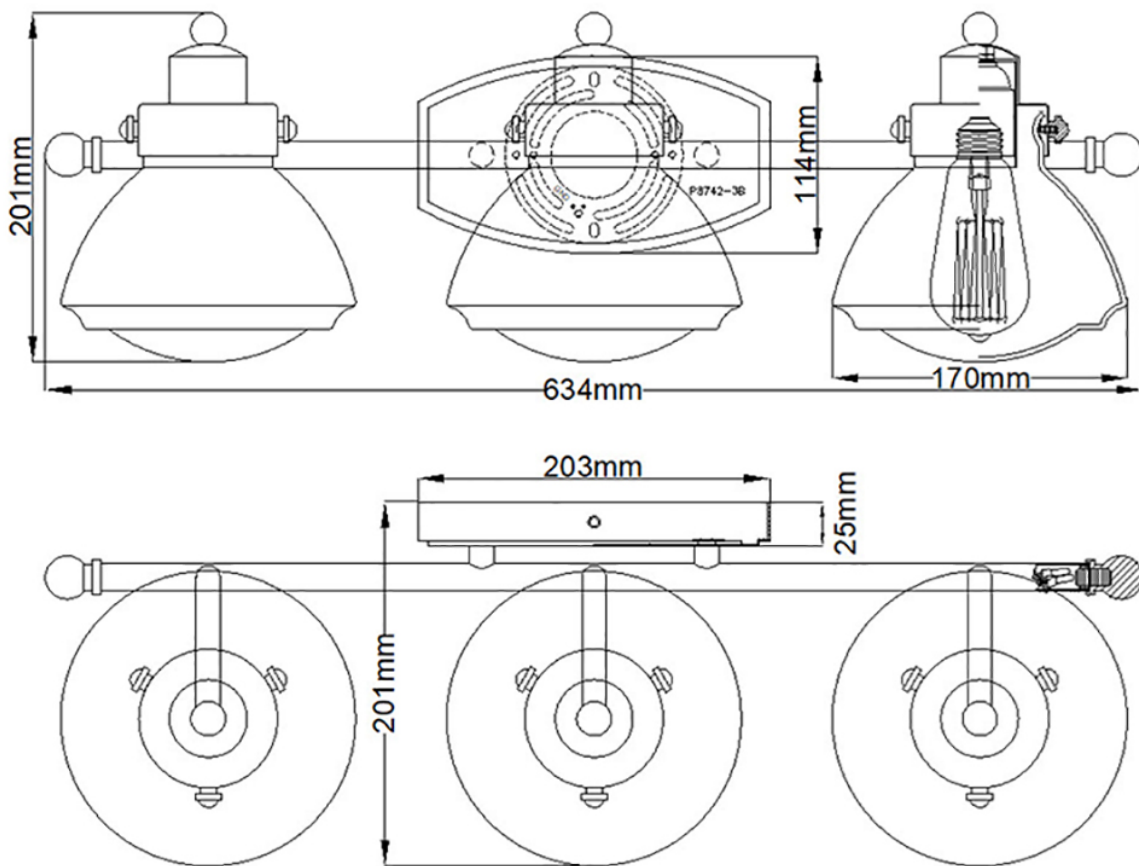

**CONTACT**