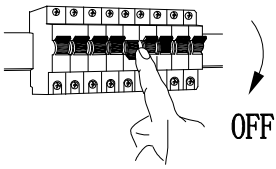
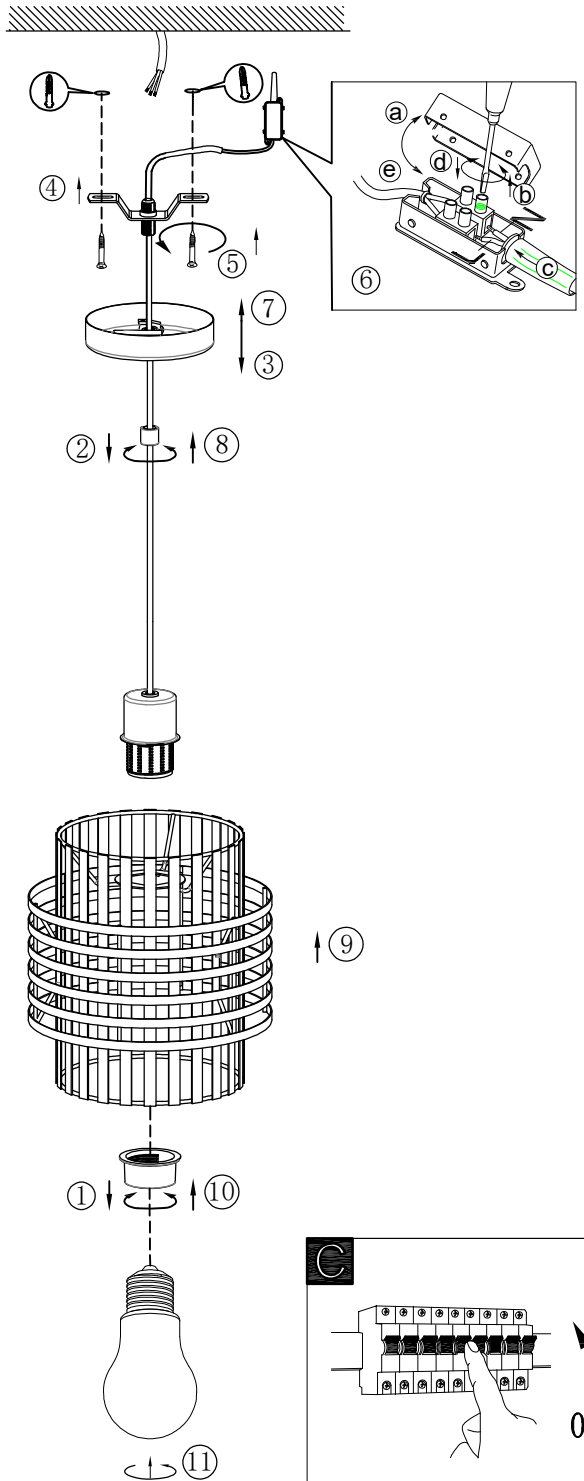
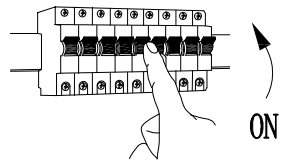

A**B****C**

B390146
www.eglo.com