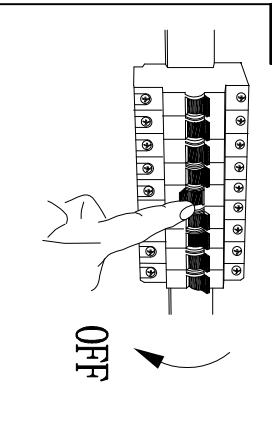
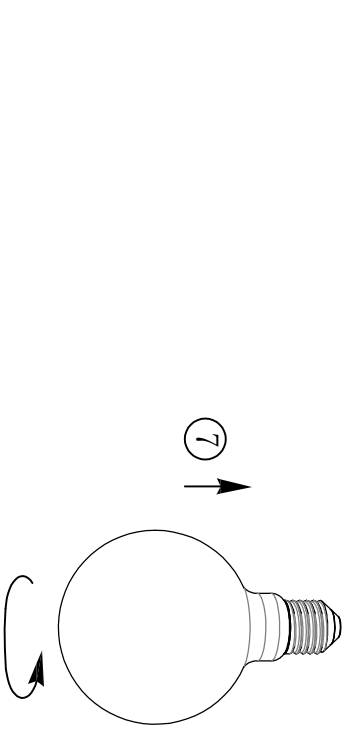
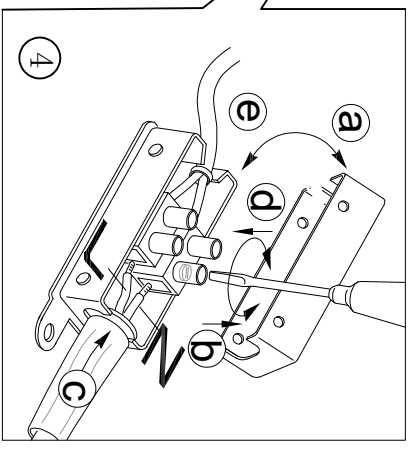
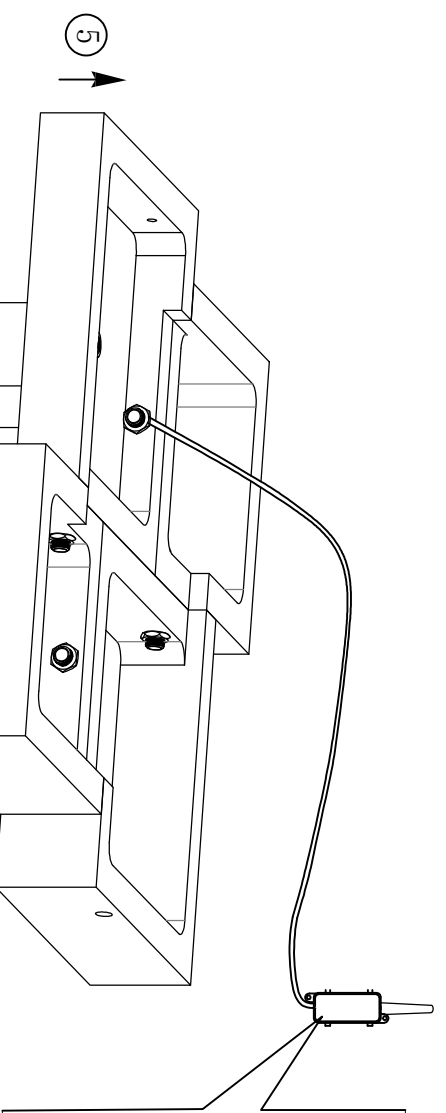
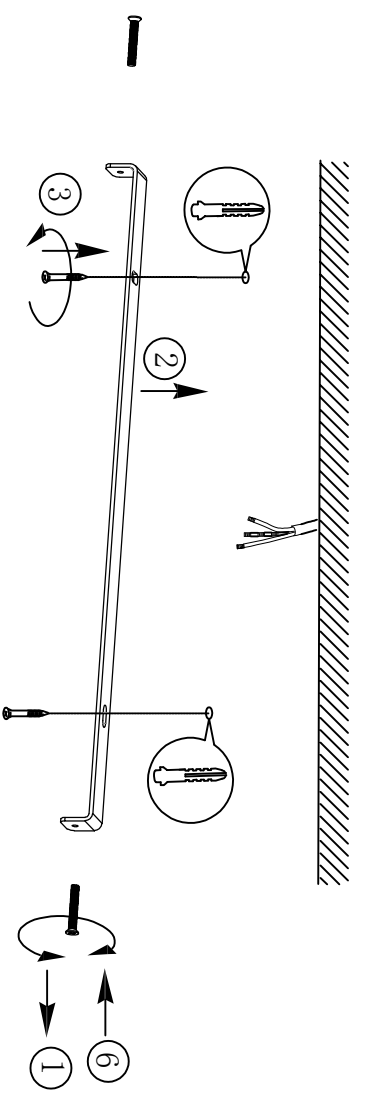
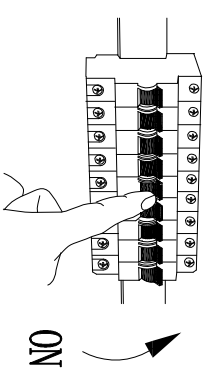

A**B****C**

B43798
www.eglo.com