

40W Max E14 SES (required)

Dimmable

FCL-81055

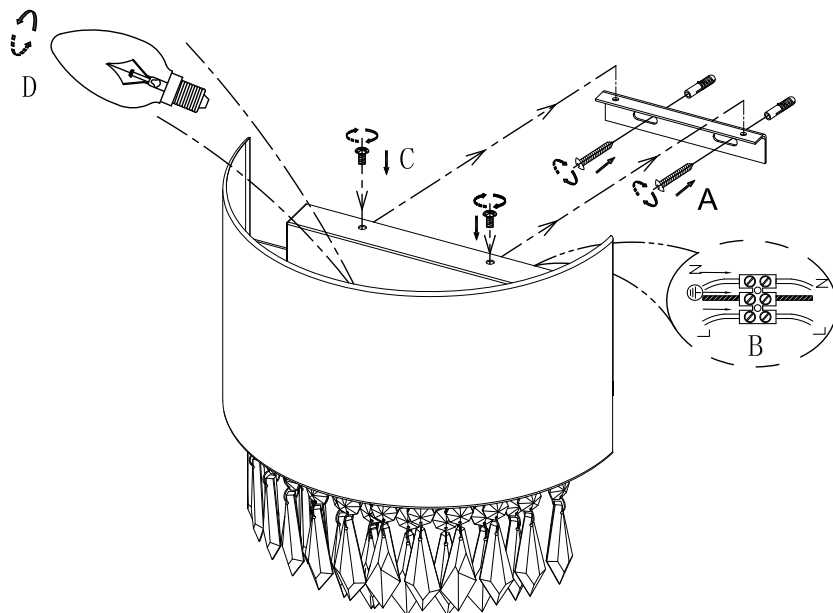

Step 1: Insert masonry plugs into mounting surface A.

Step 2: Fit mounting bracket onto mounting surface with self-tapping screws A.

Step 3: Connect main supplier wires to terminal block making sure all the connections are tight B.

Step 4: Tighten up by provided screws C .

Step 5: Insert 1xE14 bulb D(not supplied) to the lampholder.